

RNA 4900.2RS

Popular item

Abmessungen

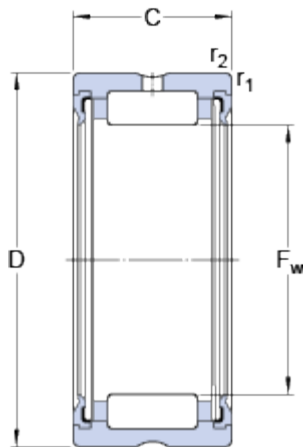

F_w	14	mm
D	22	mm
C	13	mm
$r_{1,2}$	min. 0.3	mm

Anschlussmaße

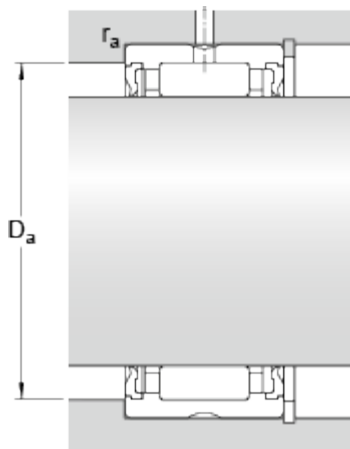

D_a	max. 20	mm
r_a	max. 0.3	mm

Berechnungsdaten

Dynamische Tragzahl	C	7.37	kN
Statische Tragzahl	C_0	8.15	kN
Ermüdungsgrenzbelastung	P_u	0.965	kN
Grenzdrehzahl		12000	r/min

Gewicht

Gewicht Lager		0.016	kg
---------------	--	-------	----